



Colt ventilation systems for car parks,
loading bays and service areas



“Maintaining ***air quality*** while ***satisfying safety requirements*** is a key challenge for car park ventilation”

Why ventilate car parks?	3
The legislation and standards	5
The design approaches for smoke ventilation	6
The design approaches for control of fume	7
Protection of lobbies and stairs	7
Multi-storey car parks	7
CFD	8
Ducted mechanical extract systems	9
Impulse ventilation systems	10-11
Induction ventilation systems	12-13
Noise control	14
Extract systems and ancillaries	14
Controls and sensors	15
Commissioning and testing	16
Why choose Colt?	16

Why ventilate car parks, loading bays and service areas?

Ventilation systems for car parks, loading bays and service areas are needed to achieve two objectives.

Day-to-day ventilation is needed to control build up of vehicle exhaust fumes or spilled fuel when the facility is in general use. Acceptable day-to-day air quality is maintained by removing exhaust gases produced by vehicles and by ensuring that there are no pockets of stagnant air.

Smoke ventilation is needed to provide a means of clearing smoke from the car park during and after a fire. This will limit smoke temperatures and structural damage and inhibit smoke spread between floors.

Smoke ventilation systems may be designed in addition to provide clear smoke-free access for fire fighters to tackle the seat of the fire or to protect means of escape from the car park. These systems are more complex and exceed the requirements of the Building Regulations. They are generally used as compensating features when other requirements of the regulations are not met.

In this leaflet we:

- *Provide an understanding of the legislative framework*
- *Explain how ventilation systems can both help meet legislative requirements and achieve design objectives*
- *Look at the equipment options.*



The legislation and standards

Throughout the UK there is legislation covering the ventilation requirements in new and refurbished car parks which needs to be satisfied.

The requirements vary slightly from country to country and are detailed in:

Smoke ventilation:

England and Wales: Approved Document B to the Building Regulations;
Scotland: Scottish Buildings Standards Technical Handbooks;
Northern Ireland: Technical Booklet E.

Day to day fume ventilation:

England and Wales: Approved Document F – Ventilation;
Scotland: Scottish Technical handbook - Non domestic. 2013 section 3.14
Northern Ireland: Technical Booklet K - Ventilation. 2012

Guidance in this document is based upon English Building Regulations.

Additional guidance is given in:

BS 7346-7:2013 - “Components for Smoke and Heat Control Systems. Code of practice on functional recommendations and calculation methods for smoke and heat control systems for covered car parks”. This covers natural ventilation, ducted mechanical ventilation and impulse ventilation, and summarises the requirements of the Buildings Regulations for both smoke ventilation and ventilation air indoor air quality,

BS 9999:2008 – “Code of practice for fire safety in the design, management and use of buildings”

BR 368 “Design Methodologies for Smoke and Heat Exhaust Ventilation” (BRE, 1999)

SCA Guide “Design of Smoke Ventilation Systems for Loading Bays and Coach Parks - a guide for system designers” (FETA, 2010).

SCA Guide “CFD Modelling for Car Park Ventilation Systems – a guide for designers and regulators” (FETA, 2007). The guidance makes it easier for designers to validate their designs and for building control bodies to sanction them. See page 8 for further info on CFD.

Defining car parks by their ventilation arrangements

The Approved Documents describe three different types of car park and set out the recommendations for each.

1. Open sided car parks

These car parks are generally above ground level, where permanent natural ventilation is available. They should have permanent wall openings on each level, equal to at least 5% of the plan area, arranged to provide cross ventilation. At least half of this should be equally arranged between two opposing walls. These openings are considered to provide sufficient ventilation for clearance of both smoke and vehicle exhaust fumes.

2. Naturally ventilated car parks

These car parks are also generally above ground level but do not have sufficient ventilation openings to class as “open sided”. They should have permanent wall openings on each level equal to at least 2.5% of the plan area, arranged to provide cross ventilation. At least half of this should be equally arranged between two opposing walls. These openings are deemed to provide sufficient ventilation for smoke clearance. However in addition mechanical extract providing three air changes per hour should be provided for day to day usage to remove exhaust fumes.

Note: The 5% and 2.5% areas are defined in Approved Document F as “aggregate equivalent areas”. They do not refer to the geometric areas. An equivalent area has an air flow performance equal to a square edged orifice of the required area.

For openings that are obstructed in any way, by louvres, screens, etc, the aerodynamic coefficient of the obstruction is needed for calculation of the equivalent area.

3. Mechanically ventilated car parks

Where natural ventilation is not possible, such as where the car park is in a basement or fully enclosed, a mechanical extract system should be provided.

The recommendation are that the system should provide 6 air changes per hour (ACH) for day-to-day ventilation on all levels and 10 ACH on the fire floor in the event of a fire. The system should be capable of operating at temperatures of up to 300°C for 60 minutes, and ductwork and fixings should be made from materials that have a melting point above 800°C. The system should have at least 2 extract fans, each providing 50% of the duty, with a secondary power supply to operate in the event of a mains power failure. Extract points should be designed with 50% of the extract at high level and 50% at low level.

With mechanically ventilated car parks Approving Authorities will be looking in particular to ensure that an air change rate to match ADB and ADF has been provided, that there is good distribution (mixing) to avoid stagnant areas, and that requirements for power supplies and 2 or more fans have been met.

Limiting the build up of carbon monoxide

In Approved Document F the ventilation arrangements described above are “deemed to satisfy” the overriding recommendation that the concentration of carbon monoxide (CO) should not exceed 30 ppm averaged over an eight hour period, and peak concentrations, such as by ramps and exits, should not exceed 90 ppm averaged over a 15 minute period.

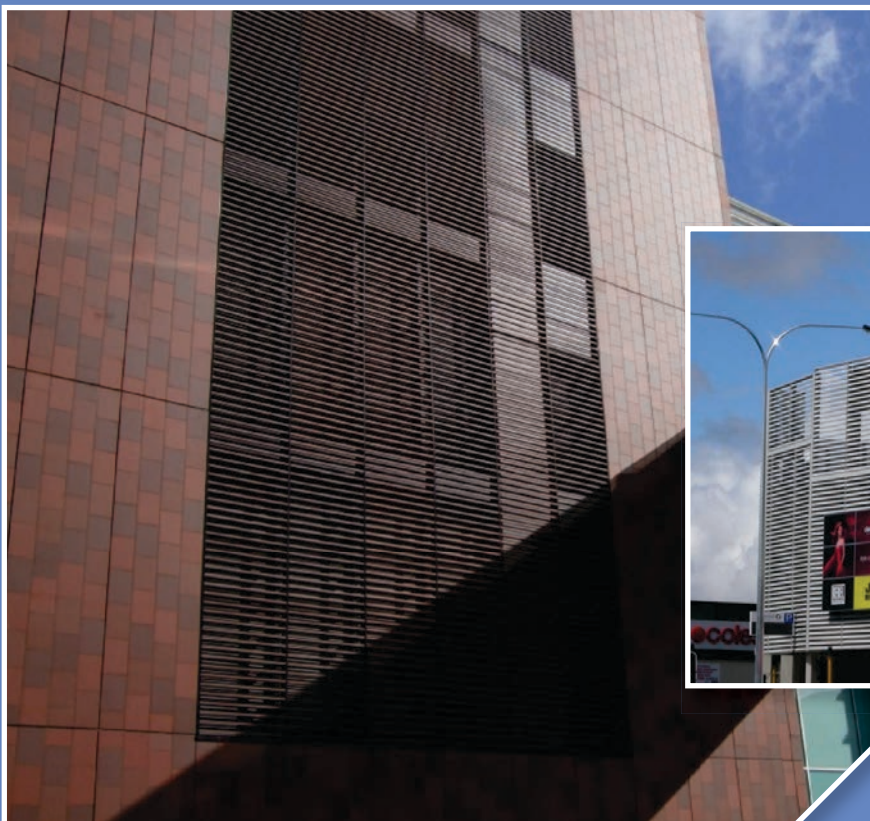



The design approaches for smoke ventilation of car parks

There are two approaches described in BS7346-7.

Smoke clearance

Such systems are not intended to assist means of escape in case of fire, but to assist fire fighters by providing smoke clearance. Even a casual inspection of the requirements shows that these methods cannot be expected to do more than limit smoke density and speed smoke clearance once the fire is extinguished.

Where impulse fans are used, they are located over the roadways in a layout engineered to ensure there are no areas where it would be possible for fumes to build up due to lack of air movement. In most car parks only a single large extract point is required, located as far as possible from the main air inlet openings. This method satisfies the requirements of both Approved Documents.

Such systems are suitable for use in sprinkler-protected car parks. However co-ordination is needed to maximise the benefits of both sprinklers and ventilation and to minimise the air velocity at sprinkler heads close to impulse fans.

Smoke control

The alternative approach is to control smoke movement in order to offset omission or reduction of other fire provisions, such as extended travel distances, lack of sprinklers or reduced compartmentation in order to enhance escape or to provide clear access for fire fighters to tackle the source of the fire. The system requires an addressable fire detection system so that the site of the fire can be pinpointed. A control system then starts only the selected impulse and extract fans to control the direction of the smoke and provide clear air in the designated part of the car park.

However it is generally a more expensive option, requiring more ventilation equipment and more complex controls.

The design approaches for smoke ventilation of loading bays and service areas

These areas are not covered by BS 7346-7. However the SCA Guide "Design of Smoke Ventilation Systems for Loading Bays and Coach Parks - a guide for system designers" provides useful information. The main differences occur when smoke control is required due to the much higher fire load from larger commercial vehicles.

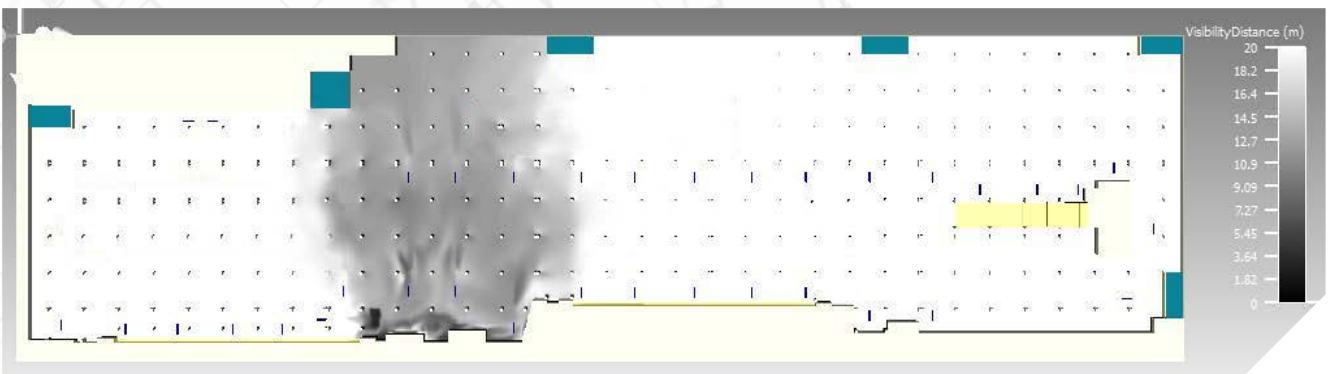
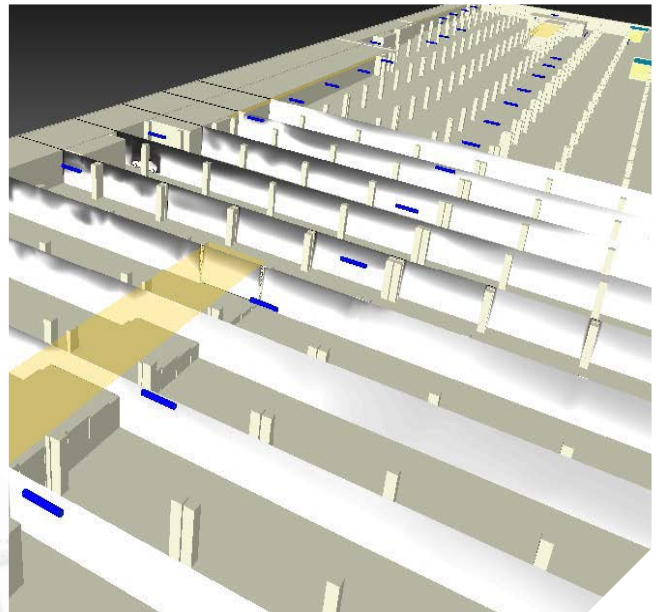
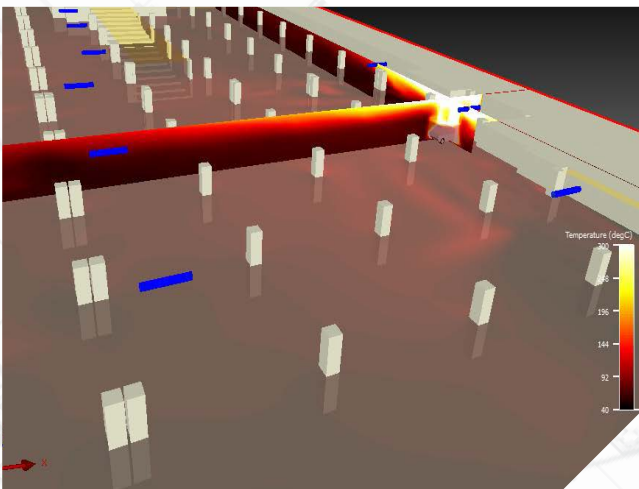

The design approaches for control of fume

When mechanical ventilation is required only for fume clearance to assist natural ventilation, the requirement is either to provide a 3 ACH system or sometimes to aid flow distribution in a large or awkward car park where an area might be missed by natural cross flow ventilation.

Two options are available: either mechanical smoke extract with impulse fan assistance, or an impulse fan only system, which needs to be reversible with wind direction control.

An impulse fan only system is often the preferred choice as space is always at a premium and extract systems are inevitably bulky. Such a system is usually only possible when the main natural openings are in walls (not the soffit) and is designed to achieve 3 ACH under no wind conditions. Wind direction controls are essential to allow the system to be reversible so that the fans assist wind driven air flows. The fans only run at low speed for fume control and are switched off in case of fire, so they can be ambient rated.

Protection of lobbies and stairs

ADB requires stair lobbies to car parks to have 0.4m² permanent natural ventilation or be protected from smoke ingress by a mechanical smoke ventilation system. To avoid the need for the natural ventilation CFD can be used

to show that the pressure in the car park outside the door is negative and no smoke is blown/drawn in through the open door.

No extra equipment is usually required but fan location and air flow direction is important.

Multi-storey car parks

In mechanically ventilated multi-storey car parks the design approach is generally to size fans based on 6 ACH for all floors together. In the fire mode fans would be run to give at least 10 ACH on the fire floor only.

Motorised smoke dampers are needed at each level to limit the extract to the fire floor only in fire mode. This discourages smoke movement to other levels.

Automatic drop curtains can be installed to separate floors or to help keep escape routes clear. These are not commonly used and can have the consequence of requiring a separate fresh air supply system if the fire floor is isolated.

Inlet air is normally provided via the entrance/exit ramp and any other available openings. In multi-storey car parks this area may be insufficient, causing excess inlet air velocities (draughts), or the air flow path to lower levels may lead to air being heavily contaminated before it reaches the lower levels. In either case a separate inlet shaft would be recommended.

Computational fluid dynamics (CFD)

The proving of alternative designs is frequently undertaken by computational fluid dynamics (CFD) analysis, and it may anyway be required by Building Control.

See SCA Guide “CFD Modelling for Car Park Ventilation Systems – a guide for designers and regulators” (FETA, 2007).

CFD can provide detailed prediction of air movement, temperature and smoke density throughout the car park, taking into account the often complex geometry of individual buildings. This level of detail cannot be provided by any other means.

For systems providing fume control and smoke clearance, CFD is commonly used simply to show that the entire car park is properly ventilated with no stagnant areas. While competent designers can often achieve proper ventilation without the need

for CFD, CFD is usually demanded by Building Control for their approval.

For smoke control systems, CFD is essential to ensure that the system keeps the required parts of the car park reasonably smoke free to allow safe access and egress.

For systems using impulse fans without an extract system to provide fume control only at 3 ACH, CFD is also essential to ensure that the fan layout is sufficient to ensure a flow of at least 3 ACH is achieved without wind assistance.

Colt can provide complete in-house CFD modelling of the system and a full technical report for local authority approval prior to installation.

This car park has a ramp providing air inlet on the left hand side, Cyclone fans distributed around the car park and extract plant on the right hand side. Red on the scale represents air speeds of 3m/s and above and dark blue represents 0m/s. These three slices show air velocities at different levels, showing that air moves right across the car park towards the extract point at all levels.

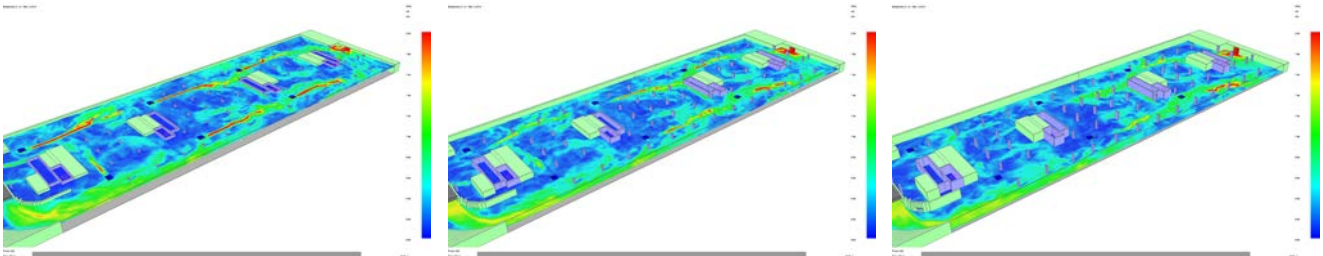

We now show an animation sequence of the same car park. The Cyclone fans are represented by blue squares. The different colour dots show different sources of pollutant, whether this be fume or cool smoke. Again we see that the air mixes evenly across the complete car park.

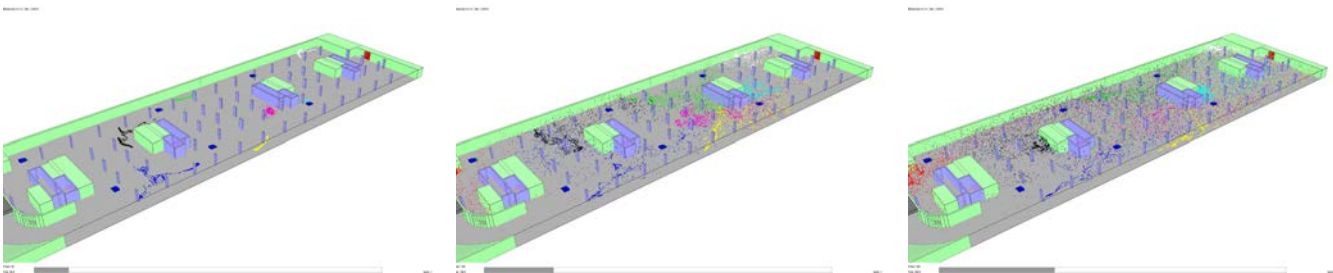

The image shows the velocity vectors produced by the CFD representation of a Colt Cyclone 100 fan unit.

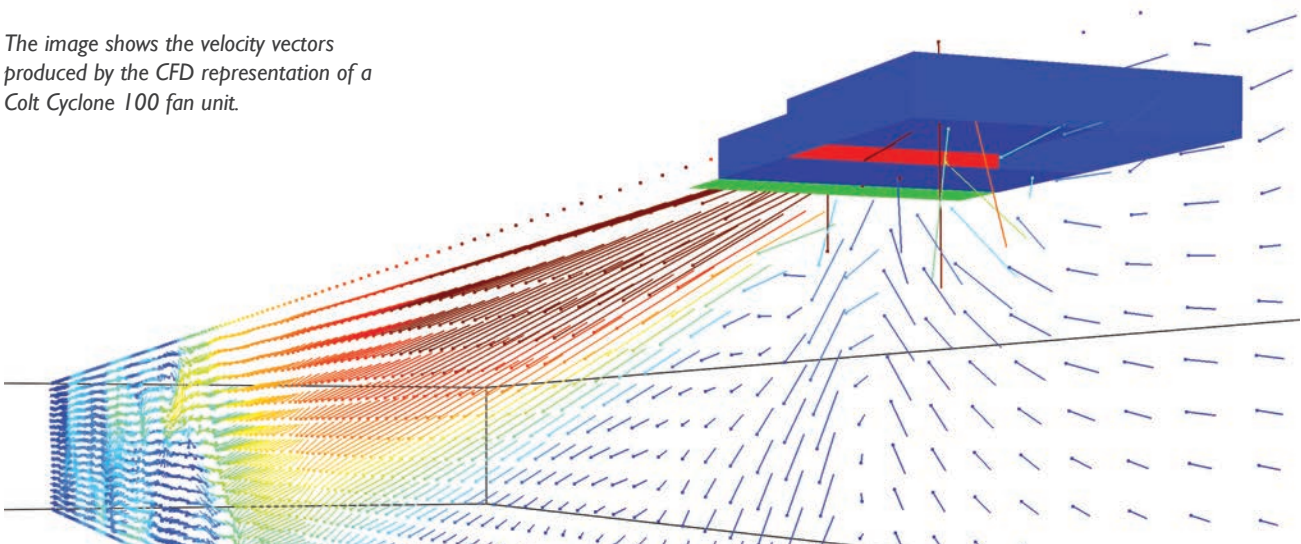

Ducted mechanical extract systems

Ducted mechanical extract systems are permitted by regulations but are rarely used nowadays due to the benefits provided by impulse systems. They tend to be used only where the car park size and geometry allows good distribution of air to be achieved without needing extensive ductwork.

The main issues relating to ducted mechanical extract systems which often cause problems for designers are:

The ductwork runs underneath the ceiling, reducing the already restricted height normally available.

Downstand beams require the ducting to be set down below them, thus diminishing the height even further.

Low level extract points are required, often needing protective barriers to surround them, and these take up valuable floor space.

The ductwork gives the car park a cluttered look and can interfere with CCTV coverage and lighting.

By contrast, impulse ventilation offers far more effective ventilation.

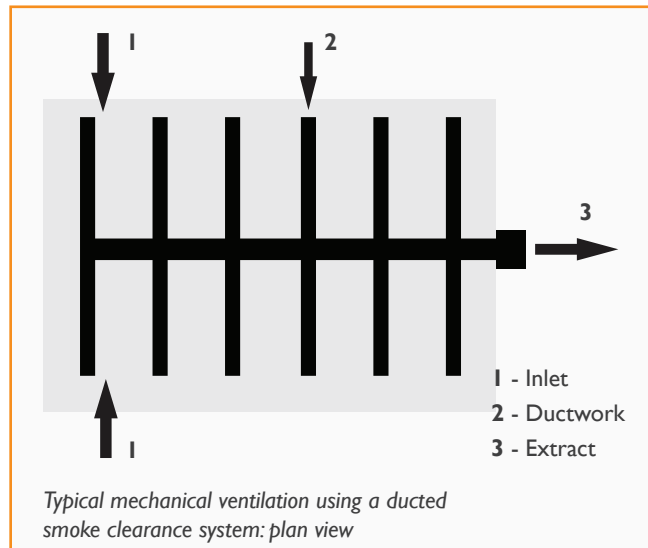
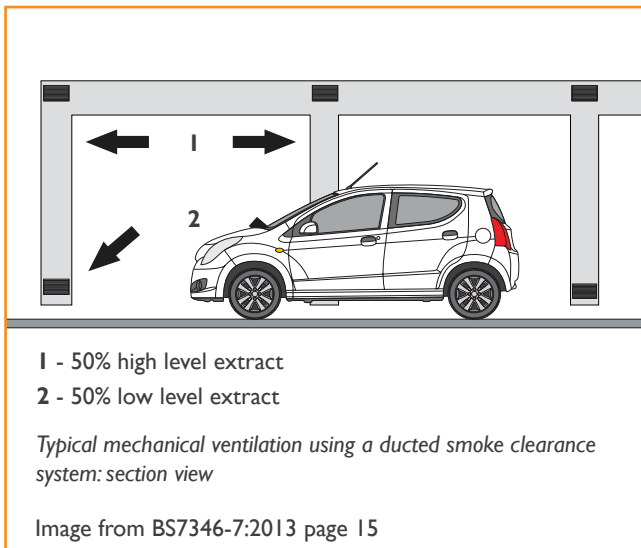

Impulse ventilation systems

Impulse ventilation systems push the air through the car park towards a single extract point, rather than pulling it to multiple extract points as a ducted mechanical extract system would. They provide greater flexibility and effectiveness.

Impulse ventilation systems comprise a series of fans located under the ceiling which generate thrust (like a jet engine) and add momentum to the air.

Using a small fan at high velocity results in a large air movement at low velocity as the jet of air spreads out. A general air flow is created towards pre-designated extract points, moving smoke and fumes with it.

The number and location of fans are carefully chosen to match the system design requirements and to ensure that there are no dead spots for fumes and smoke to stagnate and collect.



THE COLT JETSTREAM IMPULSE UNIT

General description

The Jetstream impulse unit comprises an axial fan with inlet and discharge attenuators.

Versions

Versions are available to match most customer requirements:

- Two fan sizes, 315mm and 400mm diameter, with overall depths of 335mm and 365mm respectively
- Thrusts of up to 50N
- Uni-directional or truly reversible for additional design flexibility
- Two speed, or single speed with potential for inverter control
- Ambient or high temperature smoke operation

Jetstream is 3 phase.

FEATURES AND BENEFITS

Proven performance - Independently tested and certified in accordance with EN 12101-3: 2002, achieving a F300 rating - continuous operation for one hour at 300°C.

Durable - Hot dipped galvanized finish resistant to potential corrosion.

Adjustable pitch aerofoil section impellers, set and tested in the factory, to provide optimum aerodynamic performance.

A minimum protection to IP55 on fan electrics enables fan maintenance and cleaning by pressure washing. External padlockable isolator switch protected to IP65.

Slimline appearance - Standard version uses spigot fixing of attenuators and streamlined attenuator lining to maintain a slim, clean profile.

Truly reversible - For additional design flexibility, as part of a comprehensive scheme, the control system can direct the airflow in either direction.

Quality of manufacture - Jetstream is manufactured under the BS EN 9001 quality standard. Each unit is given a functional test before despatch.

Variety of finishes - Jetstream's casing is hot dipped galvanized, whilst its attenuators are pre-galvanized sheet. It has the option of any polyester powder coating to a RAL colour.

Low noise output - CIBSE Guide Volume A:1999, Environmental Design, sets out a recommended maximum noise level of NR55 in car parks. Jetstream fans will achieve these required noise levels.

UNIT DIMENSIONS

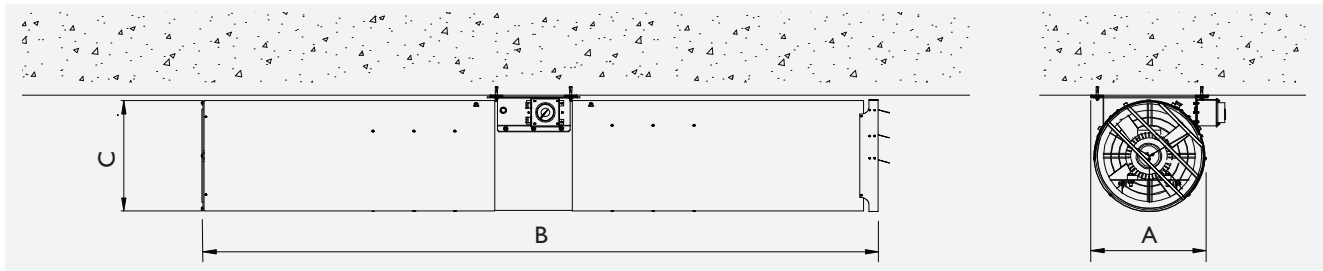

	Jetstream 315	Jetstream 400
Overall width A (mm)	315	400
Overall length B (mm)	1990	2880
Overall height C (mm)	335	427

TECHNICAL SPECIFICATION

Size	Direction	Motor power kW	Nominal current A	Start current A	Speed	Air flow m ³ /s	Discharge velocity m/s	Thrust N	LpA @ 3m free field dBA
315J	U	0.8	1.91	11.46	high	0.95	16.52	21	62
315J	R	0.8	1.91	11.46	high	0.96	16.73	20	64
400J	U	0.28	0.75	2.85	low	0.97	10.42	12	50
400J	U	1.30	2.41	14.50	high	1.95	20.91	51	64
400J	R	0.28	0.75	2.85	low	1.02	10.87	13	57
400J	R	1.30	2.41	14.50	high	2.02	21.64	52	66

J - Non flanged jet fan
 U - Uni-directional
 R - Reversible

SPECIFICATIONS

DESCRIPTION

Colt Jetstream Car Park Impulse Jet Fan - for controlling air movement in a car park or underground service area. Tested and certified to EN 12101-3.

High velocity powered car park induction ventilation unit, for directing exhaust fumes (in day to day mode) and smoke in a controlled manner towards the main extract positions of a car park or underground service area.

Comprising an axial fan with inlet and discharge attenuators with outlet diffusers enabling flush fit with the underside of the car park ceiling.

SIZES

- **Type 315** 315mm diameter fan (non-flanged)
- **Type 400** 400mm diameter fan (non-flanged)
- **U** Unidirectional
- **R** Reversible

OPTIONS

- Single speed DOL motor suitable for inverter speed control, IP55 protection
- Two speed tap wound motor (full and half speed), IP55 protection

Motors supplied either with a fitted IP55 terminal box or an optional IP65 lockable fire rated isolator.

FINISHES

- Pre-galvanised sheet (standard)
- Polyester powder coating to any RAL colour (optional)

FIRE PERFORMANCE

F300 - continuous operation for one hour at 300°C.

COMPLIANCE

The complete unit, including isolator, is rated at 300°C for 60 minutes, Class F300 to EN 12101-3 (2002). Jetstream is fully CE marked.

Induction ventilation systems

Induction ventilation systems further enhance the impulse ventilation concept.

Using the same principles as impulse ventilators, induction fans are slimmer and potentially more powerful, thus reducing the number of units required. Impulse fans are generally limited to a thrust of around 50N as they otherwise become physically too large for the constricted space available in a car park. Induction fans have thrusts up to around 100N. The floor area ventilated per fan is thus significantly greater, equating to a requirement for fewer units. However, in contrast to impulse fans, induction fans cannot generally be made reversible.

Induction fans are shorter and slimmer than impulse fans, allowing a reduced excavation cost and lower car park height. They are particularly suited for effective ventilation where downstand beams are close together as they can more easily be located between them without compromising their performance.

Fewer units mean lower cabling and controls requirements and lower installation and maintenance costs.



Colt Cyclone is a low profile, high velocity induction jet fan intended to control air movement and direct polluted air and smoke towards the extract positions in a car park or underground service area.

THE COLT CYCLONE CAR PARK INDUCTION JET FAN UNIT

General description

Colt Cyclone is a low profile, high velocity induction fan intended to control air movement in car parks and underground service areas. Cyclone reduces levels of polluted air during day to day use and assists with the extraction of smoke in the event of a fire, directing polluted air and smoke towards the extract positions in a car park or underground service area. It is tested and certified to EN 12101-3.

Cyclone uses tunnel ventilation technology to eliminate the need for costly and bulky ductwork. Compared to ductwork systems, this may save car-parking spaces, reduce running costs and noise, and make the car park a lighter, less cluttered environment.

FEATURES AND BENEFITS

Slimline design - Only 308mm or 252mm overall depth. This reduces the required headroom in car parks and thus lowers excavation costs.

Certified performance - Cyclone has been exhaustively tested and certified to EN 12101-3 in accredited third party test laboratories and is CE marked. Cyclone 100, Cyclone 50 and their standard isolators fully meet the F300 time/ temperature classifications of EN 12101-3 (300°C continuous operation for one hour). Cyclone achieved 2 hours under test.

Durable construction - Cyclone is manufactured from pre-galvanised sheet with the option of a polyester powder coating to any RAL colour.

Low maintenance - With the additional advantage that there is no ductwork to clean.

High thrust - With a higher thrust, each fan can ventilate a significantly higher floor area. This means that fewer units are required than with conventional impulse units. Fewer units mean lower cabling and control requirements as well as lower installation and maintenance costs.

Speed options - Suitable for either two speed or variable speed operation, depending on the application. Where the unit is inverter (variably) controlled, the amount of power consumed is reduced. Cyclone is 3 phase.

Low noise output - CIBSE Guide Volume A: 1999, Environmental Design, sets out a recommended maximum noise level of NR55 in car parks. When operated on inverter control, Cyclone can meet this noise level.

TECHNICAL SPECIFICATION

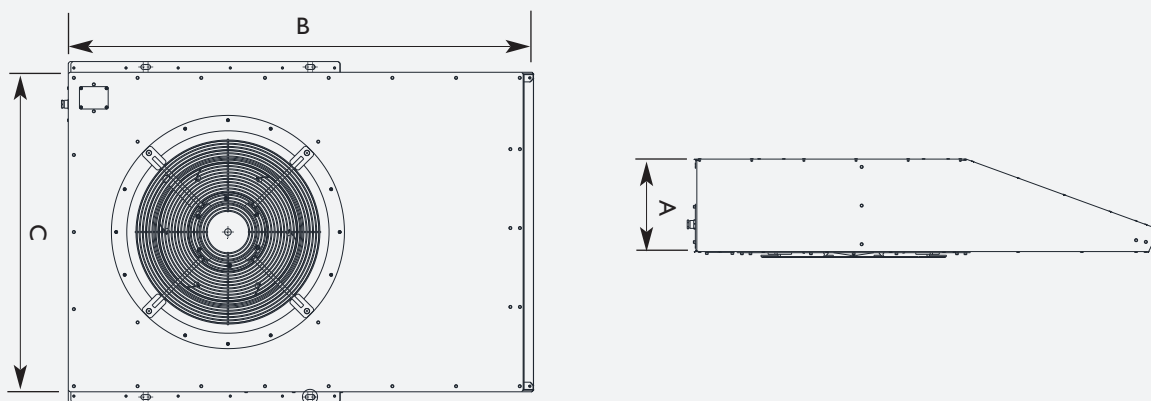

	100N Class F300	50N Class F300
Thrust	98 N / 24 N	51 N / 13 N
Discharge Velocity	32.6 m/s / 16.1 m/s	25.4 m/s / 12.6 m/s
Air Flow	2.45 m ³ /s / 1.21 m ³ /s	1.63 m ³ /s / 0.81 m ³ /s
Motor Power (full/half speed)	2.2 kW / 0.55 kW	1.2 kW / 0.3 kW
Full load current	5.6 A / 2.0 A	3.3 A / 1.5 A
LpA@3m free field (full/half speed)	71.3 dB(A) / 55.5 dB(A)	70.1 dB(A) / 53.5 dB(A)
Unit height A	308 mm	252 mm
Unit length B	1457 mm	1206 mm
Unit width C	1000 mm	830 mm

SPECIFICATION

DESCRIPTION

Colt Cyclone Car Park Induction Jet Fan - for controlling air movement in a car park or underground service area. Tested and certified to EN 12101-3.

Low profile high velocity powered car park induction ventilation unit, for directing exhaust fumes (in day to day mode) and smoke in a controlled manner towards the main extract positions of a car park or underground service area.

Incorporating a backward curved centrifugal impeller within a low profile slim-line casing manufactured from 1.5mm pre-galvanised steel with an outlet diffuser enabling flush fit with the underside of the car park ceiling.

SIZES

- Maximum 100 N thrust
- Maximum 50 N thrust

OPTIONS

- Single speed DOL motor suitable for inverter speed control, IP55 protection
- Two speed dahlander motor (full and half speed), IP55 protection

Motors supplied either with a fitted IP55 terminal box or an optional IP65 lockable fire rated isolator.

FINISHES

- Pre-galvanised sheet (standard)
- Polyester powder coating to any RAL colour (optional)

FIRE PERFORMANCE

F300 - continuous operation for one hour at 300°C. Cyclone achieved 2 hours under test.

COMPLIANCE

The complete unit, including isolator, is rated at 300°C for 120 minutes, Class F300 to EN 12101-3 (2002). Cyclone is fully CE marked.

Noise control

Noise is often a critical issue.

CIBSE Guide Volume A: 1999, Environmental Design, sets out a recommended maximum noise level of NR55 in car parks when the equipment is running in day-to-day mode. We would recommend NR55 is specified, but car park ventilation systems can be designed to achieve lower noise levels if required, although this requires fans being inverter controlled to run at lower speeds, often meaning more fans are needed and increasing costs.

External noise should always be considered, especially in urban areas. There is usually a planning condition restricting noise output from building plant. Colt can design car park ventilation systems to achieve the required noise levels.

Extract systems and ancillaries

There needs to be an adequately designed extract system to extract the air. In addition, where the natural air supply is insufficient, a supply system may also be required.

Depending on the scope required, Colt can design and provide a wide variety of mechanical extract fan and motor assemblies to suit the required duty and temperature rating. These include long case, short case and plate mounted axial fans.

Where required for smoke extraction, Colt extract fans have been tested to the exacting standards of EN 12101-3: 2002.

We can provide complete supply and extract systems tailored to meet the project requirements, including:

Ductwork, including attenuators, grilles, volume control dampers, shutoff dampers, bends and transitions.

Weathered external terminations, including louvres, dampers, turrets, gravity shutters, cowls and motorised ventilators such as the Seefire, Coltlite and Firelight.



Controls and sensors

The design of the controls including their associated sensors is an integral part of any car park ventilation system.

Day-to-day condition

The simplest (but rarely used) option is to run the system at a constant speed, providing a ventilation rate of 6 ACH throughout the car park. The most common option, chosen to significantly reduce energy usage, is to add a CO detection system to allow the system to run at a reduced ventilation rate in periods when vehicle movements are low.

Fire condition

For a smoke clearance system, single zone fire detection is all that is required for each level of the car park. Upon detection all fans on that level operate at high speed, all other fans are switched off and the extract fans are switched to full speed, extracting only from the fire level.

For a smoke control system, addressable detection is required to pinpoint the fire location to allow correct selection of fan operation to maintain the required clear areas.

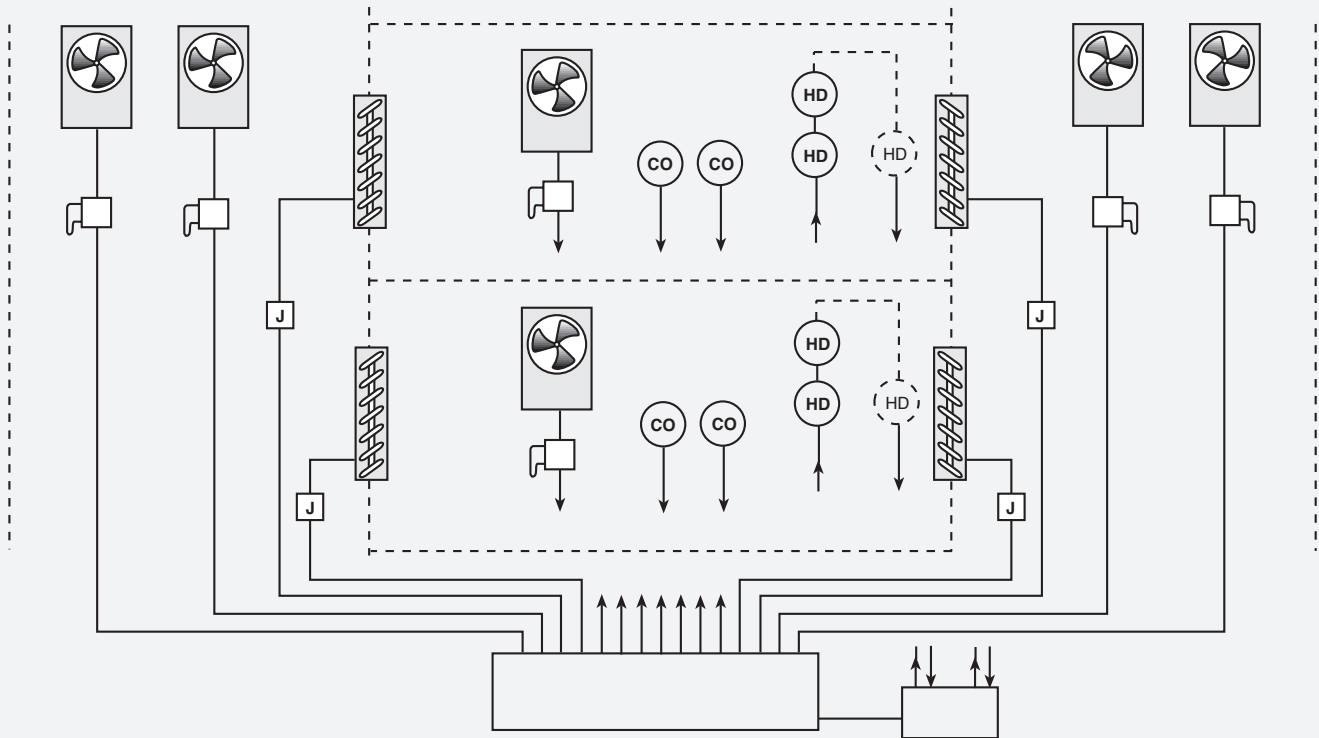

Colt can provide a full system comprising control panels, carbon monoxide (CO) detection, and an addressable heat/smoke detection system. Alternatively our control panels can be linked to the building's fire alarm system..

Typical single storey car park control sequence

For day-to-day ventilation, based on highest individual CO sensor reading:

- Low CO (less than 15ppm): half extract fans at low speed
- Normal CO (less than 30ppm): impulse fans at slow speed, half of the extract fans at slow speed
- High CO (above 30ppm): impulse fans at slow speed, all extract fans at slow speed.

For fire, initiated by detection or sprinkler flow switch or fire fighters override switch:

- Impulse fans full speed, extract fans full speed
- For smoke clearance run all impulse fans, for smoke control only run the selected impulse fans for the fire zone.
- A short delay may be built in before starting the impulse fans to allow evacuation before disturbing the smoke layer.

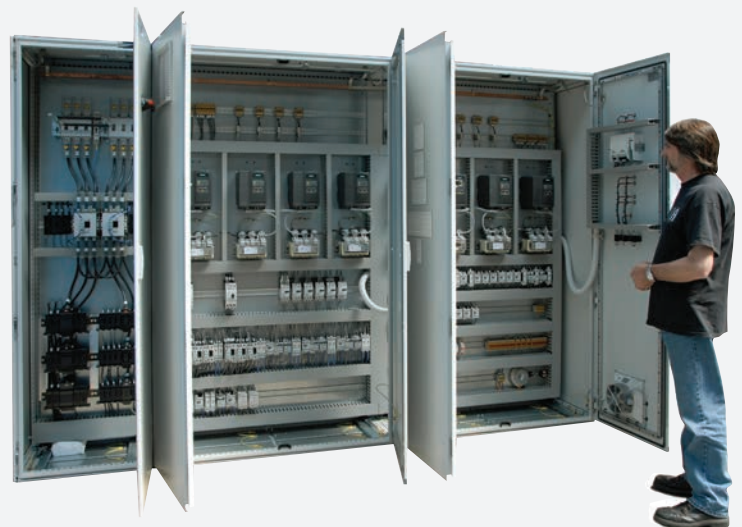

Commissioning and testing

Any mechanical or electrical system needs commissioning before use and car park ventilation systems are no exception.

Colt commissioning engineers will check the installation, set the equipment to work and set up the control system to ensure that everything works correctly in accordance with the system cause and effect chart.

Smoke testing of the completed installation is not part of the normal commissioning process but may be offered upon request.



Why choose Colt?

- We are able to provide all the equipment necessary for smoke control of multi-storey buildings: OVs, AOVs, shaft systems, access hatches, smoke dampers, smoke door and window actuators, smoke detectors, break glass switches, and manual and automatic controls.
- We can provide a complete package of scheme design, manufacture, installation, commissioning and maintenance, with the advantage that all the components are contained within one package of works.
- Every type of building presents different dynamics and requirements, and when you work with Colt, you can count on full peace of mind in every phase of the project and for the full life cycle of your system because our experts understand the engineering and architectural challenges of different buildings.

You can count on Colt to:

- Look at the complete picture: we know how a building works and have extensive in-house expertise in a broad range of technologies.
- Design the most cost-effective, no-nonsense solution engineered to meet your needs and any prevailing regulations, relying on our in-house technical resources such as CAD and CFD.
- Advise on the prevailing regulations and standards. We have the expertise to deliver smoke control systems that satisfy both the architectural demands and the safety regulations. Customise our products to fit the exact requirements of your project and, where necessary, have them specially tested at our R&D facility.
- Supply our high quality products, manufactured under quality standards and third party tested to rigorous standards. Install and commission your system: our experienced, professional project management teams will take care of everything.
- Maintain and service your system to ensure it keeps working at its most efficient throughout its life cycle.
- Train and advise through all phases of the process. We offer free technical seminars.

Service and maintenance

Our service team offers mechanical and electrical, preventative and reactive service, maintenance and repair for a wide variety of building services equipment, whether or not this has been supplied by Colt.

We provide a 24 hour, 365 day emergency cover as standard.

Maintenance of a smoke control system is essential. Regular maintenance protects your investment and brings peace of mind that the system will operate effectively in an emergency.

British Standard BS 5588-12 and BS9999 recommends that smoke control systems should be serviced at least once a year and tested weekly.

COLT INTERNATIONAL LIMITED

New Lane | Havant | Hampshire | PO9 2LY | Tel +44(0)23 9245 1111 | Fax +44(0)23 9245 4220

info@coltgroup.com | www.coltinfo.co.uk

"People feel better in Colt conditions."

© Colt International Licensing Limited 2014